

Linear

TIA 26 A030 (30W) Fixture Guide

KKDÖ

Indoor | Surface | Output up to 2340lm/m (713lm/ft)

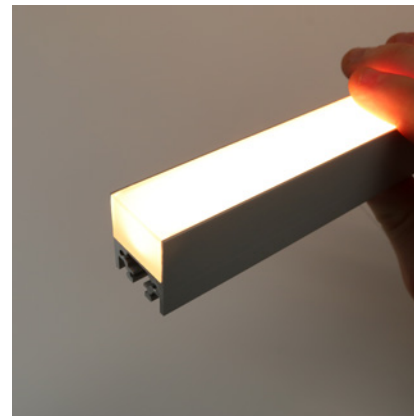

Key applications

- ✓ Ceiling
- ✓ Downlighting
- ✓ Interior
- ✓ Retail display
- ✓ Shelving display
- ✓ Under cabinet

Key features

- ✓ Diffusion: Homogenous
- ✓ Direct view
- ✓ Illuminated End Caps
- ✓ IP40
- ✓ Seamless end-to-end
- ✓ Size: 20-30mm (W)
- ✓ Up to 2000-3000lm/m

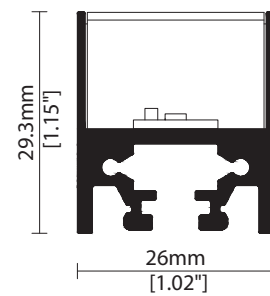

MOUNTING METHODS



KKCP-11 Concealed clip



KKBK-25 Adjustable bracket

Linear

TIA 26 A030 (30W)

Specification sheet



Dimensions	H29.3/W26/L87-2010mm (H1.15/W1.02/L3.42-79.13in)
PCB Cut-point	38.46mm increment/2000mm max (1.51in increment/78.74in max)
LED Pitch	4.8mm - 208LED/m (0.19in - 64LED/ft)
Chip	A-line
Cover/Optics	Diffused (110°)
CCT	A-line: 2700K/3000K/4000K
LED binning	A-line: 3-step MacAdam ellipse
CRI	94
Lifetime	50,000 hours @ 25°C (50,000 hours @ 77°F)
Operating temp	T _a = -25 to 45°C (T _c max = 74.5°C) T _a = -13 to 113°F (T _c max = 166°F)
IP Rating	IP40
Finish	Silver anodised
Mounting	Surface mounting via concealed clips or brackets
Power feed	Non Sheathed tail
Control	0-10V/1-10V/DMX/DALI



LED Grading Key

Exclusive Grade *KKDC tuned CCT range
A-line* 3-step CCT range
 KKDC highest lumen efficacy LED

Power consumption	Supply voltage	Supply current
30W/m (9.14W/ft)	24V DC	1.25A/m (0.381A/ft)

Performance Data (3000K)

	R1	R2	R3	R4	R5	R6	R7	R8	R9	R10	R11	R12	R13	R14
A-line	94	96	96	94	93	95	93	84	65	89	95	83	94	97

	KKLN-A1	CRI	R9	Rf	Rg
A-line	2340lm/m (713lm/ft) 78lm/W	93	65	-	-

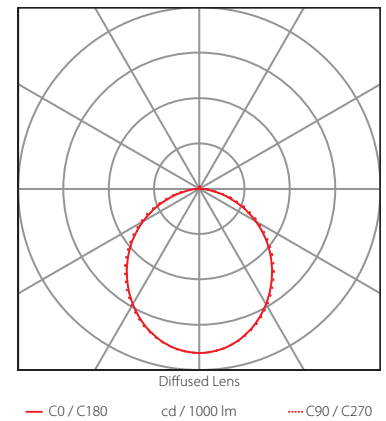
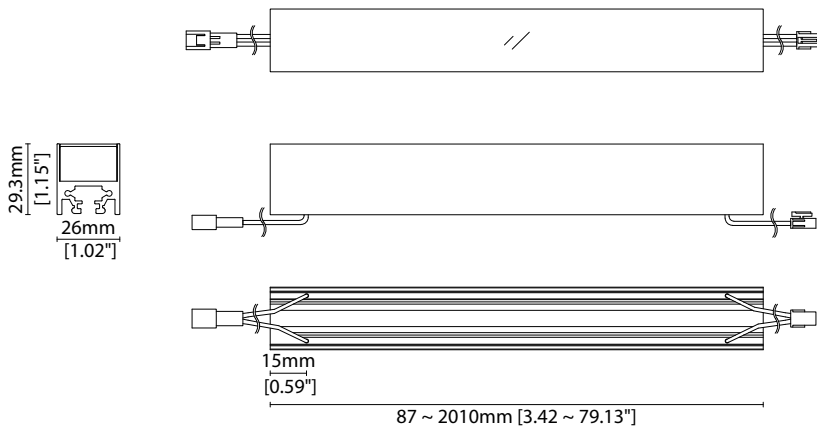

Data derived from independent UKAS/IESNA LM-79-08 accredited testing of production samples.

Linear

TIA 26 A030 (30W) Code Table



FIXTURE

Model	Finish	Cover/Lens ¹	Grade ²	LED	Colour (CCT)	Length Availability ³	IP	Cable Length	Power Feed	Input	
TIA 26	T26	Silver Anodised SA	Diffused Cover C	A- A	A030	2700K 27 3000K 30 4000K 40	m 1.87-2010mm 38.46mm increments i 1.342-79.13in 1.51in increments (Specify length code OR total run length)	IP40 40	300mm (11.81in) 0300	Single no sheath tail S00X Double no sheath tail D00X Single no sheath IP20 connector S20X Double no sheath IP20 connector D20X	DC 24V g

¹ Refer to **Cover/Lens options** on **Options** page

² Refer to **LED Grading Key** on **Specification sheet** page

³ Refer to **Length Availability List** or enter total run length instead of length code

Code Example:

T26	-	SA	-	C	-	A	-	A030	-	30	-	m	-	510	-	40	-	0300	-	S00X	-	g
TIA 26		Silver Anodised		Diffused Cover		A-		A030		3000K		510mm		IP40		300mm (11.81in)		0300		Single no sheath tail		DC 24V

ACCESSORIES

Mounting Accessories

KKCP-11	Concealed Clip
KKBK-25	Adjustable bracket

* Refer to **Mounting accessories** on **Accessories** pages

Connection Accessories

KKCN-01	2 PIN male & female 50mm/1.97" pair
KKCN-03	2 PIN male & female 300mm/11.81" pair
KKCN-06	2 PIN 300mm/11.81" extension lead

* Refer to **Power feed** on **Accessories** pages

PSU/Driver

0-10V/1-10V/DALI/DMX

* Refer to **Driver/PSU Options** page for details or provide requirement and KKDC to offer the suitable option

Linear

TIA 26 A030 (30W)

Length Availability List



Length Code		Fixture Length ¹		LED Strip ²		End Cap Dimension		Wattage (W)	Output (lm)
Metric	Imperial(US)	Metric	Imperial(US)	Metric	Imperial(US)	Metric	Imperial(US)		3000K (Test Data)
m0087	i0003	87mm	3.43in	77mm	3.03in	N/A	N/A	2.31	180
m0125	i0005	125mm	4.94in	115mm	4.55in	N/A	N/A	3.46	270
m0164	i0006	164mm	6.45in	154mm	6.06in	N/A	N/A	4.62	360
m0202	i0008	202mm	7.97in	192mm	7.57in	N/A	N/A	5.77	450
m0241	i0009	241mm	9.48in	231mm	9.09in	N/A	N/A	6.93	540
m0279	i0011	279mm	11.00in	269mm	10.60in	N/A	N/A	8.08	630
m0318	i0013	318mm	12.51in	308mm	12.12in	N/A	N/A	9.23	720
m0356	i0014	356mm	14.02in	346mm	13.63in	N/A	N/A	10.39	810
m0395	i0016	395mm	15.54in	385mm	15.14in	N/A	N/A	11.54	900
m0433	i0017	433mm	17.05in	423mm	16.66in	N/A	N/A	12.69	990
m0472	i0019	472mm	18.57in	462mm	18.17in	N/A	N/A	13.85	1080
m0510	i0020	510mm	20.08in	500mm	19.69in	N/A	N/A	15.00	1170
m0549	i0022	549mm	21.60in	539mm	21.20in	N/A	N/A	16.16	1260
m0587	i0023	587mm	23.11in	577mm	22.72in	N/A	N/A	17.31	1350
m0625	i0025	625mm	24.62in	615mm	24.23in	N/A	N/A	18.46	1440
m0664	i0026	664mm	26.14in	654mm	25.74in	N/A	N/A	19.62	1530
m0702	i0028	702mm	27.65in	692mm	27.26in	N/A	N/A	20.77	1620
m0741	i0029	741mm	29.17in	731mm	28.77in	N/A	N/A	21.92	1710
m0779	i0031	779mm	30.68in	769mm	30.29in	N/A	N/A	23.08	1800
m0818	i0032	818mm	32.19in	808mm	31.80in	N/A	N/A	24.23	1890
m0856	i0034	856mm	33.71in	846mm	33.31in	N/A	N/A	25.39	1980
m0895	i0035	895mm	35.22in	885mm	34.83in	N/A	N/A	26.54	2070
m0933	i0037	933mm	36.74in	923mm	36.34in	N/A	N/A	27.69	2160
m0972	i0038	972mm	38.25in	962mm	37.86in	N/A	N/A	28.85	2250
m1010	i0040	1010mm	39.77in	1000mm	39.37in	N/A	N/A	30.00	2340
m1049	i0041	1049mm	41.28in	1039mm	40.89in	N/A	N/A	31.16	2430
m1087	i0043	1087mm	42.79in	1077mm	42.40in	N/A	N/A	32.31	2520
m1125	i0044	1125mm	44.31in	1115mm	43.91in	N/A	N/A	33.46	2610
m1164	i0046	1164mm	45.82in	1154mm	45.43in	N/A	N/A	34.62	2700
m1202	i0047	1202mm	47.34in	1192mm	46.94in	N/A	N/A	35.77	2790
m1241	i0049	1241mm	48.85in	1231mm	48.46in	N/A	N/A	36.92	2880
m1279	i0050	1279mm	50.36in	1269mm	49.97in	N/A	N/A	38.08	2970
m1318	i0052	1318mm	51.88in	1308mm	51.49in	N/A	N/A	39.23	3060
m1356	i0053	1356mm	53.39in	1346mm	53.00in	N/A	N/A	40.39	3150
m1395	i0055	1395mm	54.91in	1385mm	54.51in	N/A	N/A	41.54	3240
m1433	i0056	1433mm	56.42in	1423mm	56.03in	N/A	N/A	42.69	3330
m1472	i0058	1472mm	57.94in	1462mm	57.54in	N/A	N/A	43.85	3420
m1510	i0059	1510mm	59.45in	1500mm	59.06in	N/A	N/A	45.00	3510
m1548	i0061	1548mm	60.96in	1538mm	60.57in	N/A	N/A	46.15	3600
m1587	i0062	1587mm	62.48in	1577mm	62.08in	N/A	N/A	47.31	3690
m1625	i0064	1625mm	63.99in	1615mm	63.60in	N/A	N/A	48.46	3780
m1664	i0066	1664mm	65.51in	1654mm	65.11in	N/A	N/A	49.62	3870
m1702	i0067	1702mm	67.02in	1692mm	66.63in	N/A	N/A	50.77	3960

TIA 26 A030 (30W)

Length Availability List



Length Code		Fixture Length ¹		LED Strip ²		End Cap Dimension		Wattage (W)	Output (lm)
Metric	Imperial(US)	Metric	Imperial(US)	Metric	Imperial(US)	Metric	Imperial(US)		3000K (Test Data)
m1741	i0069	1741mm	68.53in	1731mm	68.14in	N/A	N/A	51.92	4050
m1779	i0070	1779mm	70.05in	1769mm	69.66in	N/A	N/A	53.08	4140
m1818	i0072	1818mm	71.56in	1808mm	71.17in	N/A	N/A	54.23	4230
m1856	i0073	1856mm	73.08in	1846mm	72.68in	N/A	N/A	55.38	4320
m1895	i0075	1895mm	74.59in	1885mm	74.20in	N/A	N/A	56.54	4410
m1933	i0076	1933mm	76.11in	1923mm	75.71in	N/A	N/A	57.69	4500
m1972	i0078	1972mm	77.62in	1962mm	77.23in	N/A	N/A	58.85	4590
m2010	i0079	2010mm	79.13in	2000mm	78.74in	N/A	N/A	60.00	4680

¹ Actual total overall length of light fixture (LED strip + end caps + void/wire hole)

² Actual length of PCB strip

³ Actual length of 2x end caps

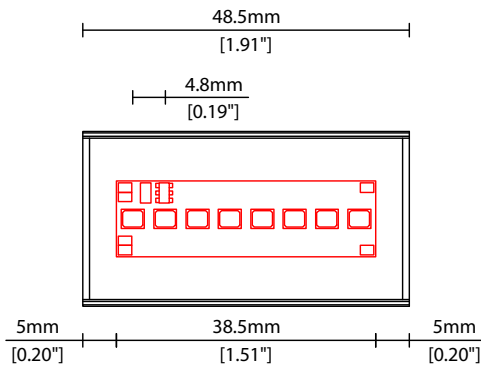

Linear

TIA 26 A030 (30W)

Options

KKDC

COVER/LENS OPTIONS

* Options are an integral part of the fixture ordering codes. Please refer to **Code Table** pages.



C Diffused cover
W26/H29.3mm (W1.02/H1.15")

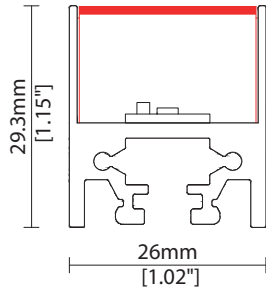

Key

Control Gear Power supply, sub-controllers & control systems
JB Junction box / cable connection

POWER FEED OPTIONS

* Options are an integral part of the fixture ordering codes. Please refer to **Code Table** pages.

0300 S00X 300mm (11.81") Single no sheath tail

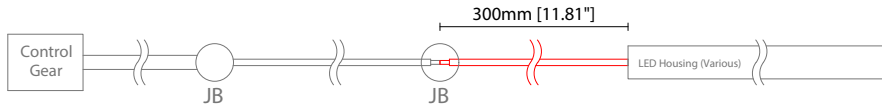

0300 D00X 300mm (11.81") Double no sheath tail

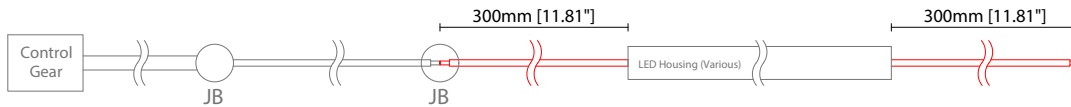

0300 S20X 300mm (11.81") Single no sheath IP20 connector

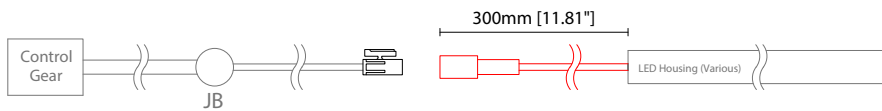

0300 D20X 300mm (11.81") Double no sheath IP20 connector

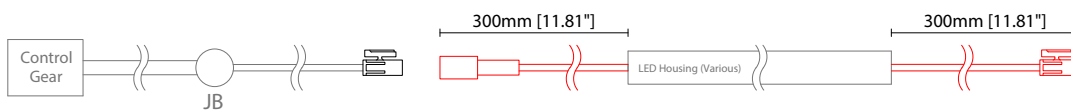

2 Pin Female Connector

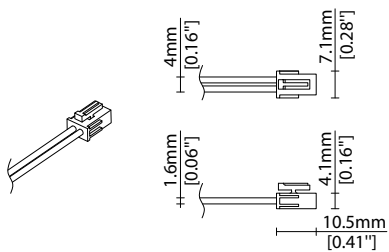

2 Pin Male Connector

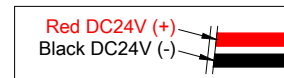
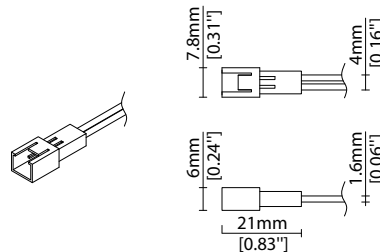

Key

- Control Gear Power supply, sub-controllers & control systems
- JB Junction box / cable connection

MOUNTING ACCESSORIES

Note: Accessories are to be ordered separately with corresponding code shown below.



KKCP-11
 Concealed clip
 (allow 3 per metre/40in)
 S/Steel finish
 L20/W26/H22.1mm
 (L0.79/W10.2/H0.87")

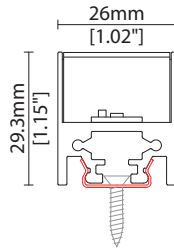

KKBK-25
 Adjustable bracket
 (allow 2 per metre/40in)
 Anodised aluminium finish
 L30/W40/H29.6mm
 (L1.18/W1.57/H1.16")

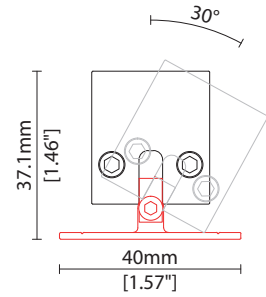

POWER FEED

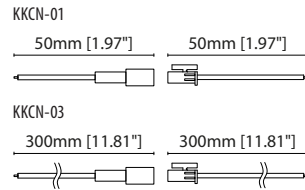
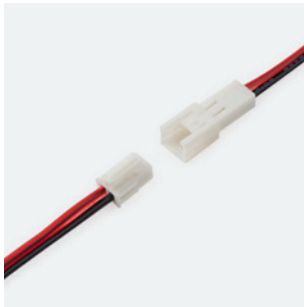

KKCN-01 50mm (1.97in) pair
KKCN-03 300mm (11.81in) pair
 2 PIN male + female connector set

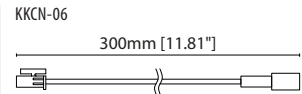

KKCN-06
 2 PIN 300mm (11.81in) extension lead

POWER FEED

Linear

TIA 26 A030 (30W)

Accessories

KKDÖ

KKDC CONTROL



IP20
Plastic housing
L170/W59/H29mm
(L6.69/W2.32/H1.14in)

KKDM-06 1-10V

visDIM dimmable sub-controller
(4 x 8A max @ 12-36V)



IP20
Plastic housing
L170/W53.4/H28mm
(L6.69/W2.10/H1.10in)

KKSC-05 DMX

visDIM dimmable sub-controller
(4 x 5A max @ 12-36V)



IP20
Plastic housing
L170/W59/H29mm
(L6.69/W2.32/H1.14in)

KKDL-02 DALI

visDIM dimmable sub-controller
(4 x 8A max @ 12-36V)



IP20
Plastic housing
L166/W53.4/H23mm
(L6.54/W2.10/H0.91in)

KKDL-03 DALI

visDIM dimmable sub-controller
(4 x 5A max @ 12-36V)

AVAILABLE PSU OPTIONS

Control Mode	PSU (Order Code)	Input Voltage AC	Output Voltage DC	Rated Output Current	Rated Power	Dim %	IP Rating
Switched	CEN-60-24	90-295V	24V	2.5A	60W	-	IP67
	HLG-60H-24	90-305V	24V	2.5A	60W	-	IP67
	HLG-100H-24	90-305V	24V	4.0A	100W	-	IP67
	HLG-150H-24	90-305V	24V	6.3A	150W	-	IP67
	HLG-240H-24	90-305V	24V	10A	240W	-	IP67
0-10V (1-10V)	PWM-40-24	90-305V	24V	1.67A	40W	100-0.15 (100-10)	IP67
	PWM-60-24	90-305V	24V	2.5A	60W	100-0.15 (100-10)	IP67
	PWM-90-24	90-305V	24V	3.67A	90W	100-0.15 (100-10)	IP67
	PWM-120-24	90-305V	24V	5.0A	120W	100-0.15 (100-10)	IP67
DALI	LIN100A1	120-277V	24V	1A per channel	100W	100-0.1	IP66/IP40
DMX RGB	LIN100A1	120-277V	24V	1.33A per channel	100W	100-0.1	IP66/IP40
DMX RGBW	LIN100A1	120-277A	24V	1A per channel	100W	100-0.1	IP66/IP40

Flicker Free Options - Combination of PSU+ sub-controller

Control Mode	PSU (Order Code)	Sub-controller (Order Code)	Input Voltage AC	Output Voltage DC	Rated Output Current	Rated Power	Dim %	IP Rating PSU/ Sub-controller
0-10V or 1-10V	CEN-60-24	KKDM-06	90-295V	24V	2.5A	60W	100-0.9	IP67/IP20
	HLG-60H-24	KKDM-06	90-295V	24V	2.5A	60W	100-0.9	IP67/IP20
	HLG-100H-24	KKDM-06	90-295V	24V	4.0A	100W	100-0.9	IP67/IP20
	HLG-150H-24	KKDM-06	90-295V	24V	6.3A	150W	100-0.9	IP67/IP20
	HLG-240H-24	KKDM-06	90-295V	24V	10.0A	240W	100-0.9	IP67/IP20
DALI	CEN-60-24	KKDL-02/03	90-295V	24V	2.5A	60W	100-0.1	IP67/IP20
	HLG-60H-24	KKDL-02/03	90-305V	24V	2.5A	60W	100-0.1	IP67/IP20
	HLG-100H-24	KKDL-02/03	90-305V	24V	4.0A	100W	100-0.1	IP67/IP20
	HLG-150H-24	KKDL-02/03	90-305V	24V	6.3A	150W	100-0.1	IP67/IP20
	HLG-240H-24	KKDL-02/03	90-305V	24V	10.0A	240W	100-0.1	IP67/IP20
DMX RGB	CEN-60-24	KKSC-05	90-295V	24V	2.5A	60W	100-0.9	IP67/IP20
	HLG-60H-24	KKSC-05	90-305V	24V	2.5A	60W	100-0.9	IP67/IP20
	HLG-100H-24	KKSC-05	90-305V	24V	4A	100W	100-0.9	IP67/IP20
	HLG-150H-24	KKSC-05	90-305V	24V	6.3A	150W	100-0.9	IP67/IP20
	HLG-240H-24	KKSC-05	90-305V	24V	10.0A	240W	100-0.9	IP67/IP20

¹ The items shown above cover the most frequently used specification but does not exhaust the possible options

² PSU and/or driver can be chosen from the table, or KKDC may recommend the best option upon receipt of the controls requirement and installation environment

³ Electrical shop drawing will include detailed information of PSU and relevant control drivers

⁴ Cut sheets are available on the controls section of www.kkdc.lighting or upon request